

Article number: 20191B12B122NI

Description: E+G

T-angle clamps GN191-B12-B12-22-NI

## Measures

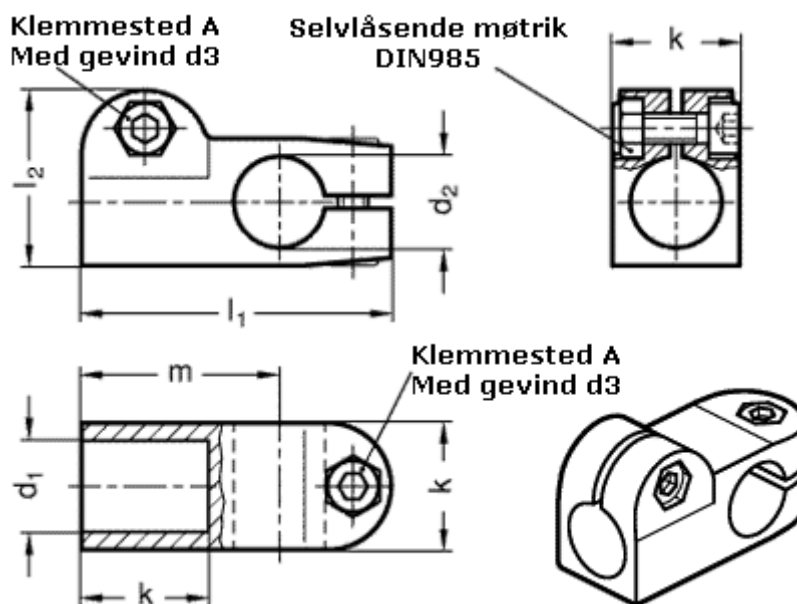

d1 = B12

d2 = B12

d3 = M 6

k = 25

l1 = 61

l2 = 34.5

m = 39